

ANA Cargo

Company Profile

ANA Cargo www.anacargo.jp/en/

To be chosen air logistics provider

As society and the economy changes and logistics become increasingly dynamic, we offer outstanding value as the world's leading airline.

Based on Boeing large freighter aircrafts, ANA Cargo has evolved into a full service cargo carrier and continues taking on challenges to meet all kinds of air cargo requirements.

As a combination carrier with both freighter and passenger aircrafts, we will further expand our network,

connecting Japan, China, Asia, Europe, and North America, establishing resilient system to promptly meet customers' needs.

Our sufficient aircrafts and various product lineups allows us to handle all kinds of cargo,

while our stable air logistics infrastructure with distribution function enables to provide reliable quality.

ANA Cargo will spur innovation in air logistics and continuously create new value for the world.

CARGO + [*Innovation*]

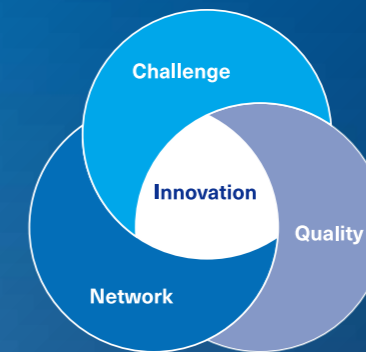

Extensive network and service only ANA Cargo can achieve

ANA Group boasts its longstanding history and performance in the air transport world. As a member, ANA Cargo, utilizing the group's mobilized extensive network and sufficient aircrafts, facilities, service, will provide full range of high services under secured support framework.

CARGO + [Network]

ANA's air network

We can flexibly combine air network covering approximately 50 cities in Japan and 45 cities abroad. This enables us to carry customers' cargo to every corner of the globe with speed and reliability.



P07~08

Freight Support Center

Comprehensive service of warehouse handling to customs clearance is provided in the same bonded warehouse adjacent to ANA terminal, which normally is conducted at other facilities outside the airport. This simple, convenient service reduces total lead time.



P09~13

New Model of Okinawa International Logistics Hub

Based on utilization of passenger flights operating to Naha airport, an air network will be established, connecting overseas and local cities of Japan via Okinawa as a logistics nodal point. Cargo products departing from Okinawa will be enhanced also.



P14

CARGO + [Quality]

ANA Cargo service responds to ever-diversifying cargo characteristics

We offer products and services tailored to our customers' diversifying transport needs.

The PRIO series gives top priority to global business needs

Deliver things anywhere in the world faster and more accurately. Our PRIO series' diverse lineup meets global business needs with a "guaranteed priority."

P19

Made-to-order transport plans

We offer charter service to fit your highly specialized transport needs. We'll propose the optimal plan, with reliable quality.



Quality you can count on



CEIV is a quality certification program for the air transport of pharmaceutical products, formulated by the International Air Transport Association (IATA). ANA Cargo was the first Japanese airline to obtain this international quality guarantee, the "IATA CEIV Pharma Certification", at Narita International Airport. This ensures safety, security, compliance, and efficiency based on uniform international standards in accordance with Good Distribution Practices (GDP).

P20



ANA Cargo is the only Japanese airline who is a member of IATA's affiliate organization Cargo IQ, which comprises shipment management, process optimization, and IT solution providers. Listing its missions as "shipment management", "process optimization", and "standardization", it transcends the boundaries of individual companies and strives to establish standards for the airline industry as a whole.

A wide variety of aircraft

Freighters



Passenger aircrafts



The ANA Group currently has more than 200 aircraft of various models, including Boeing 777 and 767 freighters. By making the most effective use of these, not only can we achieve safety, reliability, and speed, but we are also able to flexibly handle cargos of any shape.

P17

Containers for kinds of cargo

From ordinary containers to exclusive containers for freighters and cooling containers, ANA Cargo has more than 20 different types of ULDs. We handle all kinds of cargo.



P18

Photo: Envirotainer AB

CARGO + [Challenge]

2 types of freighters matches various needs of cargos with different weight, dimension, etc.

ANA Group owns Boeing freighters of 777s and 767s.

We are able to load and transport cargo with weights and sizes which cannot be carried on passenger aircrafts. We also utilize high-quality temperature-controlled containers for cargo requiring strict temperature control, such as pharmaceutical products.

We take full advantage of our abundant aircrafts to flexibly handle cargo of various shapes and conditions, realizing reliable, safe, and speedy transport.

Faster, Farther, and Beyond

Beyond the limits

Our new B777 freighters will support future air logistics and connect the world

Our B777 freighters (nickname : "BLUE JAY") can hold 102 tons of cargo, approximately twice as much as B767 freighters. They provide an optimal solution for the additional expansion in cargo volumes caused by economic growth in developing countries, as well as for the advanced supply chain of the global era.



New B777s

This aircraft can handle large cargo that used to be difficult to transport due to its size or other constraints. It's now possible to transport semiconductor manufacturing equipment and machine tools.

Nickname



BLUE JAY
CARGO + [Challenge]

"BLUE JAY"

[California Blue Jay is a very beautiful blue bird.]
Japanese name: Aokakesu

The nickname "Blue Jay" is the name of a beautiful bird with the same blue hue as ANA's color. The sight of a blue jay working steadily and diligently to carry food is reminiscent of ANA aircraft. The logo images a blue jay soaring powerfully and majestically through the sky, filled with sense of mission and joy in regard to transport.

—	B777 Freighter
—	B767 Freighter
—	B777 Freighter / B767 Freighter
—	Passenger Flight

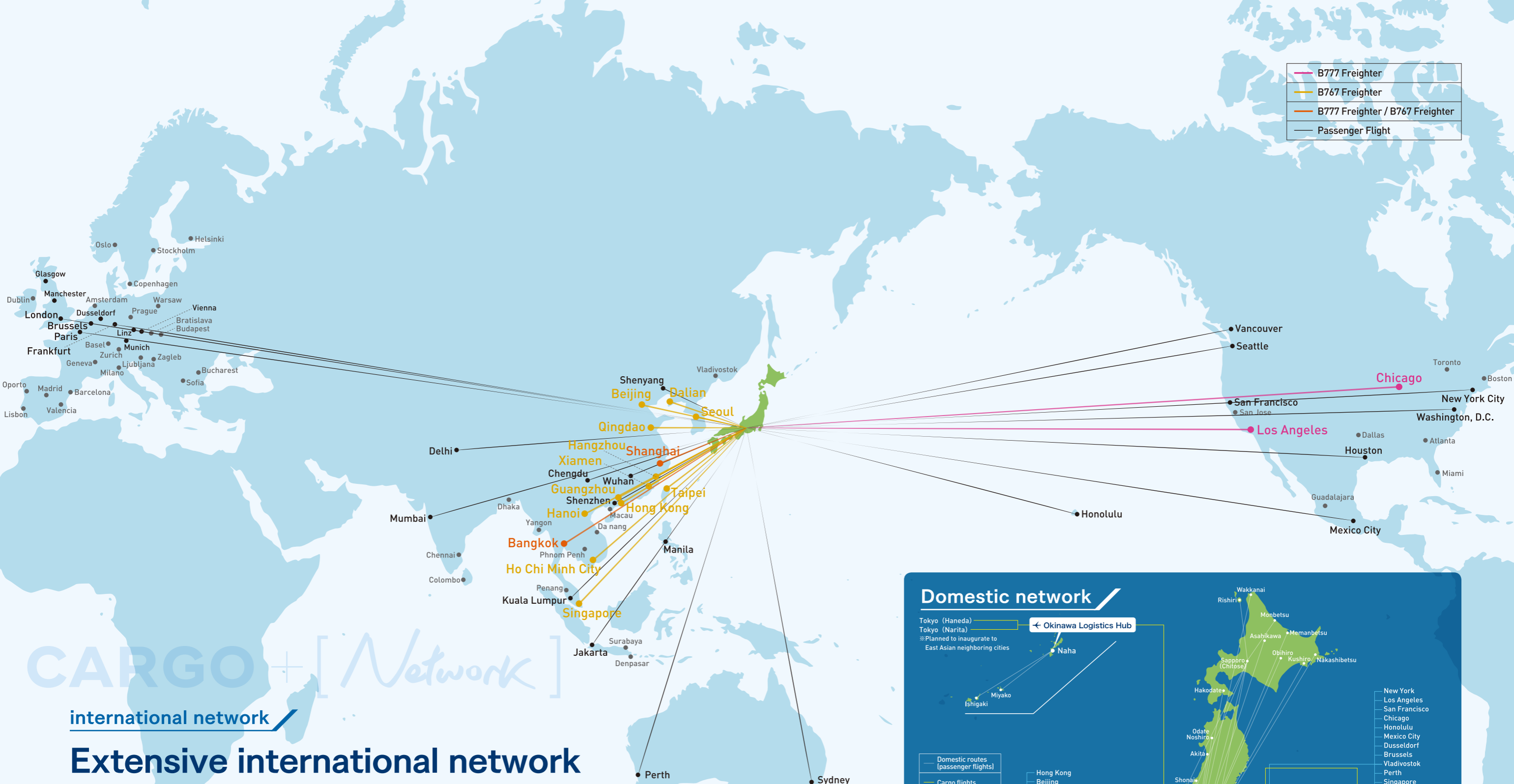

CARGO + [Network]

international network

Extensive international network connecting the world and largest Japan domestic network enables to provide stable transportation.

The ANA Group's air network is continually evolving. We deliver our customers' cargo smoothly to anywhere, including transport from major cities worldwide to nearby cities by truck.

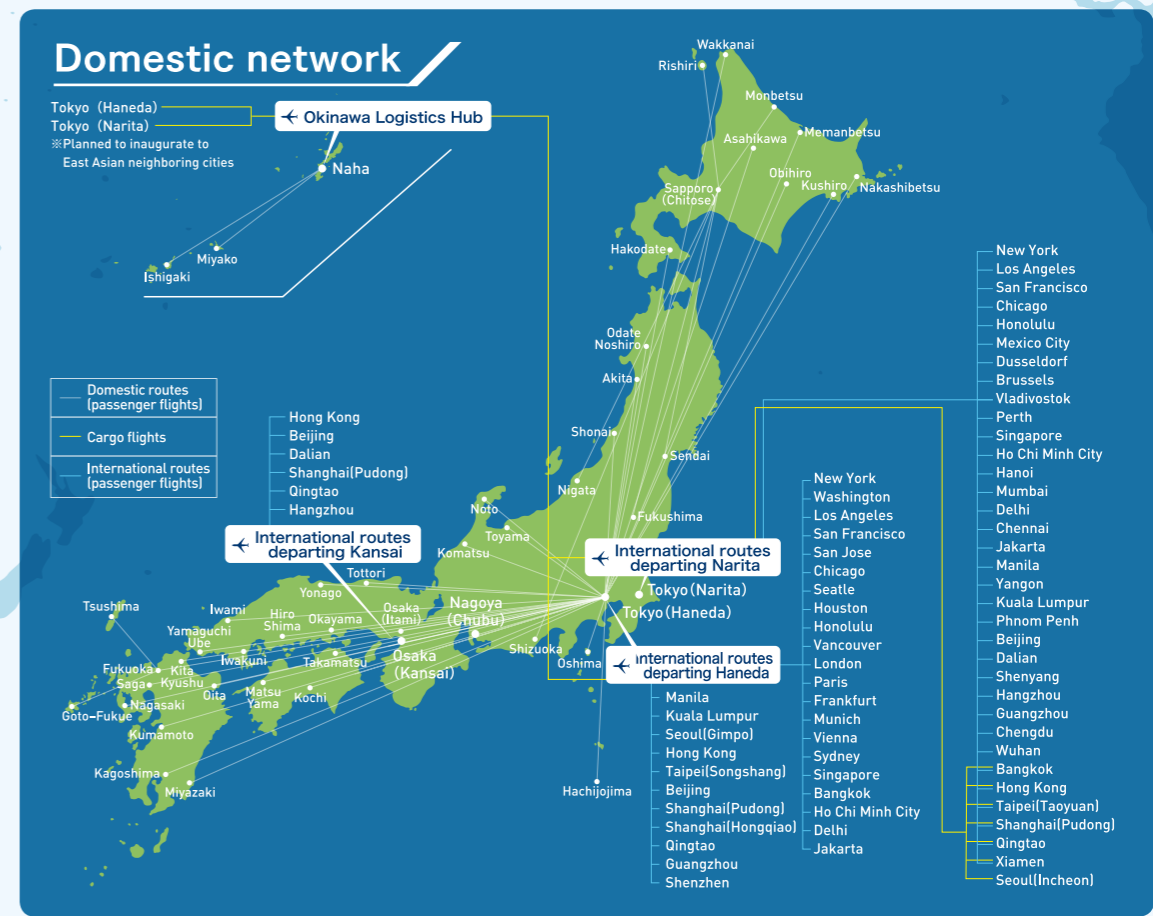

※As of October 2022

Freighter Network

As a combination carrier utilizing both freighters and passenger aircraft, responding to customers' diversifying needs is possible.

By operating Boeing 777 and 767 freighters, the commodities such as semiconductor manufacturing equipment or completed cars which are loadable only on the freighters can be reliably and safely transported to the major cities in North America, Europe or Asia.

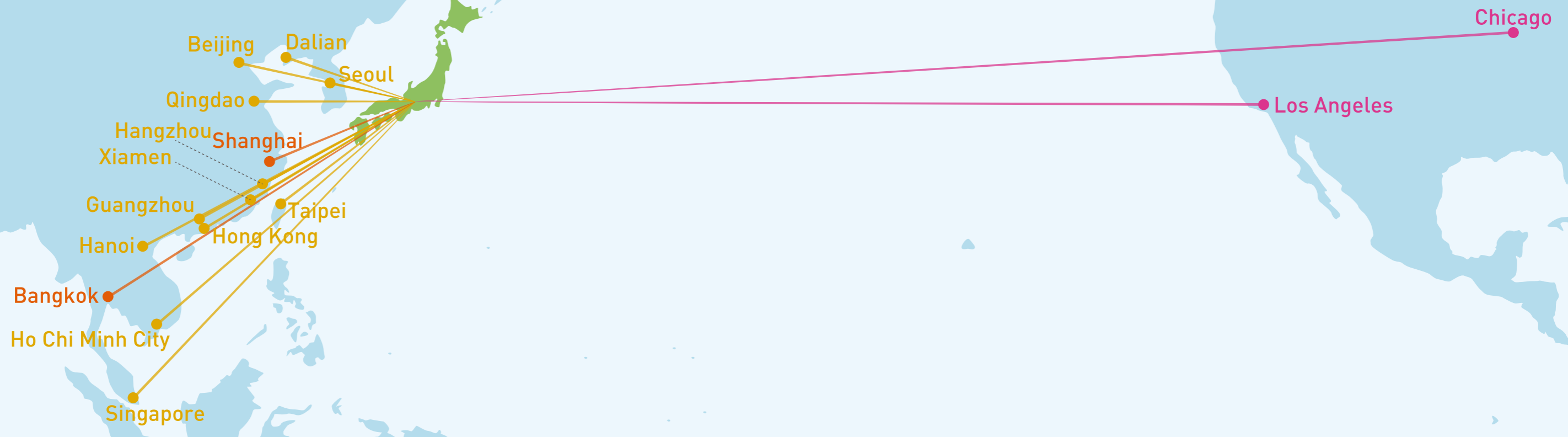

—	B777 Freighter
—	B767 Freighter
—	B777 Freighter / B767 Freighter

※As of October 2022

CARGO + [Network]

ANA Cargo

International Logistics Solution

Normal warehouse handling ~ customs clearance performed outside the airport facilities shall be collectively managed at the bond warehouse adjacent to ANA terminal.

The simple, convenient service will reduce the total lead time.

Based on advantages of ANA Cargo, support will be provided to establish an optimal mechanism of international logistics for the customers' businesses.

Freight support center

Freight Support Center

Customs clearance•warehouse handling will be provided at ANA cargo warehouse in Haneda•Naha•Kansai•Narita airports. (Service is also provided on Sat•Sun•holidays)



3 POINTS of Freighter Support Center

POINT 1: Customs clearance

Customs clearance will be performed in the ANA international cargo warehouse. Requests are accepted also on weekday off-business hours, Saturday, Sunday, holidays.

POINT 2: Warehouse handling

Warehouse handling such as measurements, labeling will be performed in the ANA international cargo warehouse. Only warehouse handling is also acceptable.

POINT 3: Japan domestic transfer service

Utilizing ANA's domestic network, optimal delivery considering speed and cost will be provided, combining flight and land transportation.

Product set with ANA's transport services



Please feel free to contact us if you have any interest in ANA's transport service "PRIO STRAIGHT *1" or "PRIO CONNECTION *2".

*1 Product combining "Customs clearance service for exports" & "Air transport"
*2 Product combining "Air transport from local airports" & "Customs clearance for exports"

Characteristics of freight support center

One stop operations

Established "seamless operations" by customs clearance•airline warehouse integration. "Reduction of logistics process & total lead time" is possible by performing warehouse handling ~ airline delivery at the same facility in Haneda airport.

ANA group's integrated operations

ANA group will provide "standardized quality" based on integrated operations. "Enhancement of security level" and "prevention of damages" is possible by ANA group's integrated and standardized operations.

Air logistics scheme utilizing freight support center

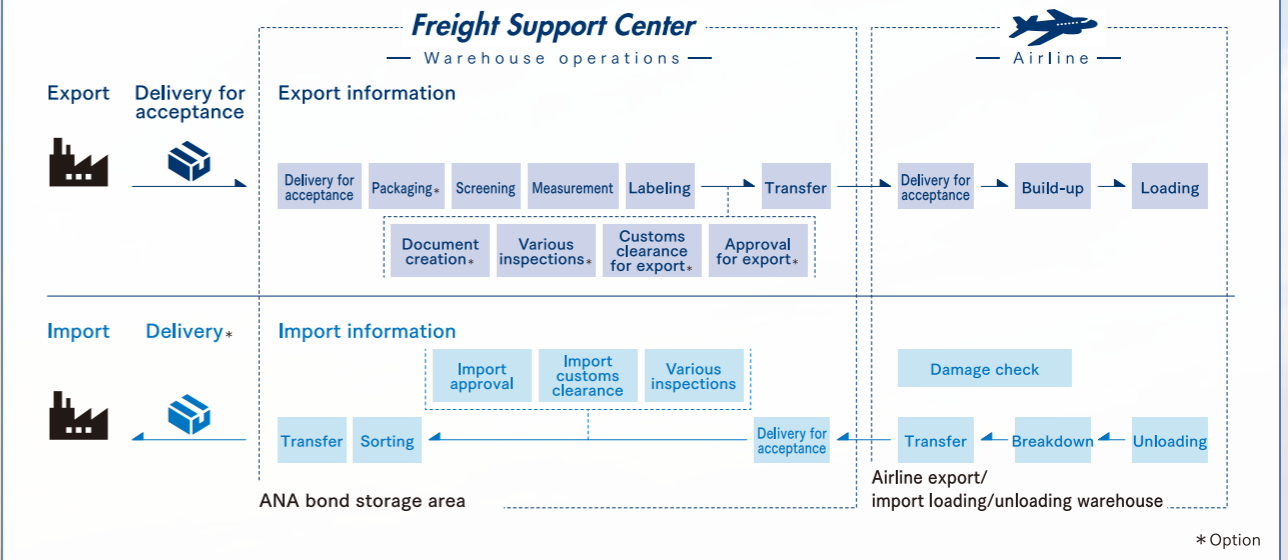

Speed is Value (Cargo + Speed)

Promptly deliver from origin to arrival point

Introduction of handling cases

Utilize Toyosu market and Haneda airport in the early morning delivering to the restaurant in Hong Kong keeping its freshness

Recommended items

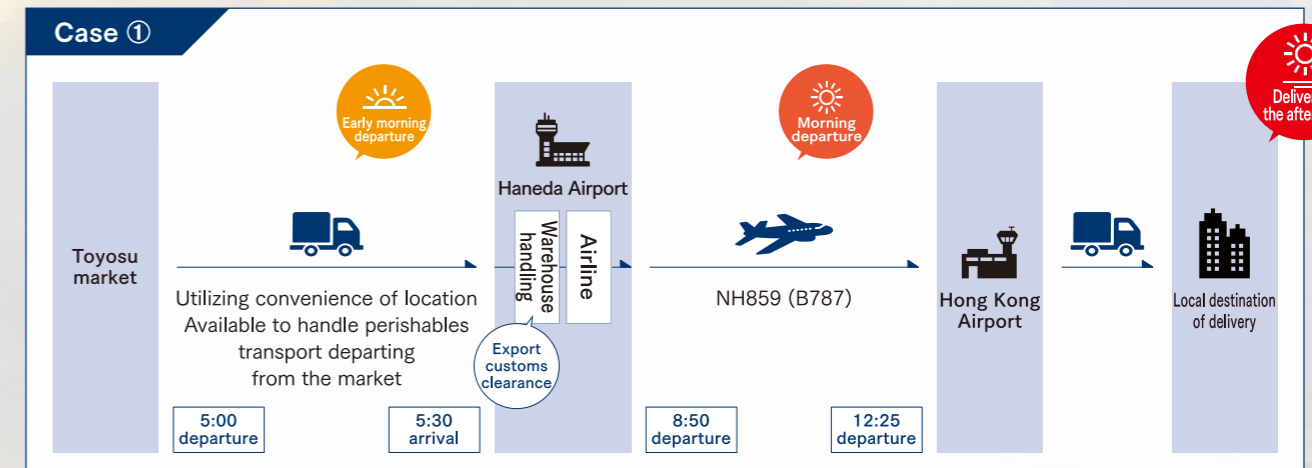

After the concert, transport orchestra instruments to the hall in Frankfurt utilizing Haneda airport

Recommended items

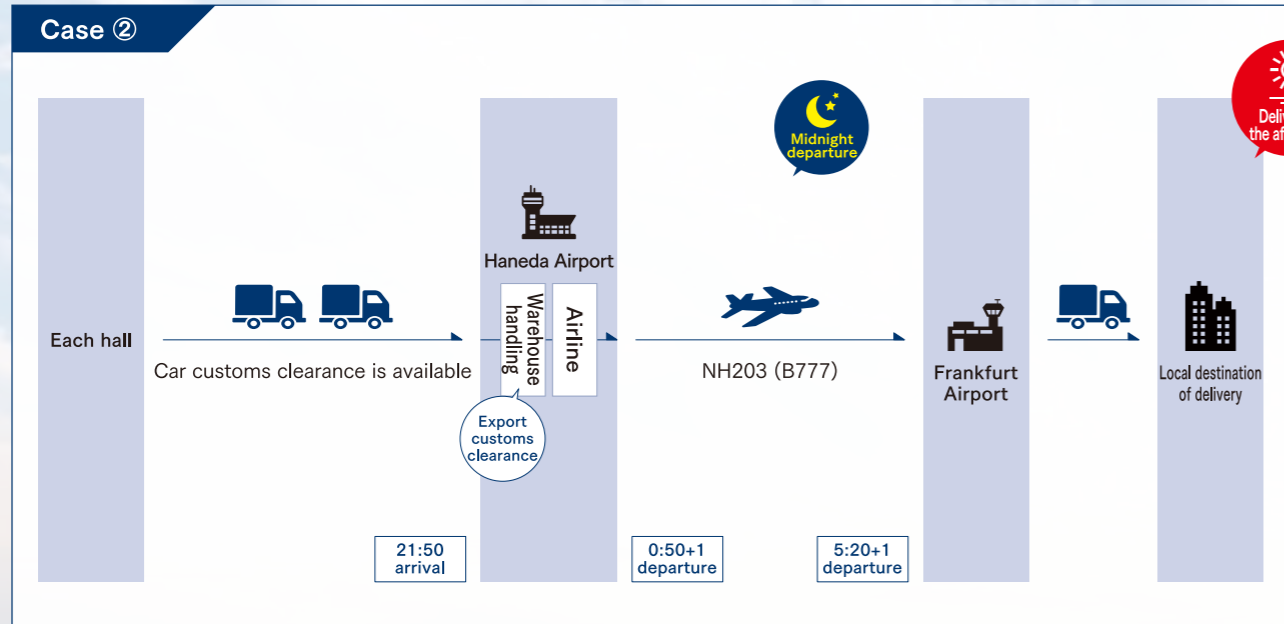

Utilizing Haneda airport for emergency transportation of aircraft parts to maintenance factory in Singapore

Recommended items

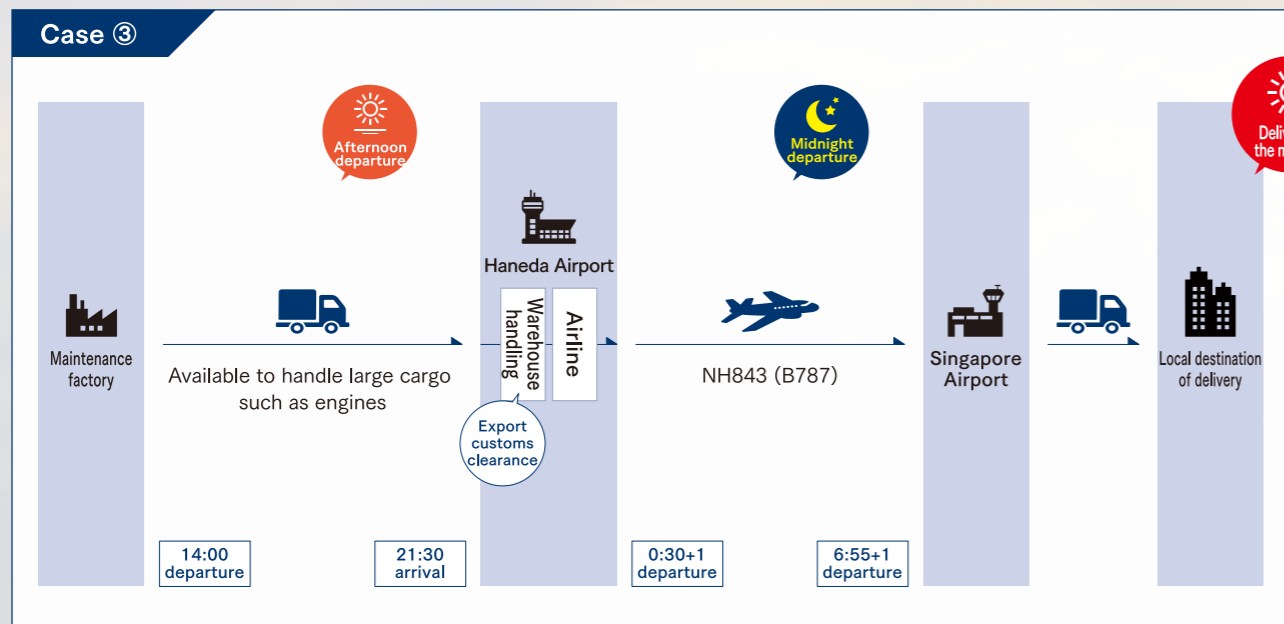

CARGO + [Network]

New Model of Okinawa International Logistics Hub

Based on utilization of passenger flights operating to Naha airport, an air network will be established, connecting overseas and local cities of Japan via Okinawa as a logistics nodal point. Cargo products departing from Okinawa will be enhanced also.

Network of Okinawa International Logistics Hub New Model

Utilization of international passenger flights' cargo space operating at Naha airport will enable frequent and small lot transport to more destinations than now. Okinawa international logistics hub is to be a model to continuously make development as the pillar of both passenger and cargo by enhancing partnership with each carrier.



Enhancement of Product Competitiveness for Okinawa Departure Cargo

Prioritized loading and secured low-temperature transport of Okinawa departure export cargo to be loaded on domestic-international routes from Metropolitan dual airports (Handa-Narita), utilizing domestic services (Okinawa-Haneda), will be enhanced. Especially, for many of the cargo departing from Okinawa, which are agricultural products requiring low-temperature control, the very best quality transportation will be realized by providing services utilizing cooling containers or thermal blankets*, as well as securing cooling storage at the transit airports (Haneda-Narita). Also, in cooperation with the partner airlines, cooling quality of other carriers will be enhanced.



OKINAWA Fresh Express

Load guarantee

Load guarantee service on the reserved flight
Will guarantee loading on the reserved domestic-international flights.

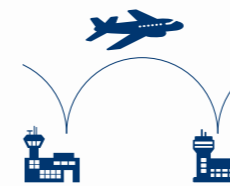

Guaranteed cool temperature transport-storage for perishable cargo

Cool-constant temperature control transport service based on the required temperature. Recommendable for transport of perishable cargo, such as fresh fish-vegetables and fruits, required to keep its freshness.

- 1 ANA's cool container
- 2 Guarantee cool storage at departure, arrival, transit airports
- 3 Thermal blanket

Using dry ice type cooling container. Low temperature transport is available to the arrival airport. Temperature range: -15°C~+5°C



In addition to departure-arrival airports, cool storage at transit points (Narita/Haneda) is guaranteed.



Using thermal blanket (Tyvek® Covers). Recommendable for normal temperature transport of vegetables-fruits during high temperature summer season.



* Form of transportation can be selected by the customers. (If cooling transport is not required, only loading guarantee service will be applied)

B777

B777 freighter

This large freighter has a cruising range of 9,200 km and load capacity of approximately 100 tons. Speedily transports various shipments, including special cargo, via Asia=North America network.

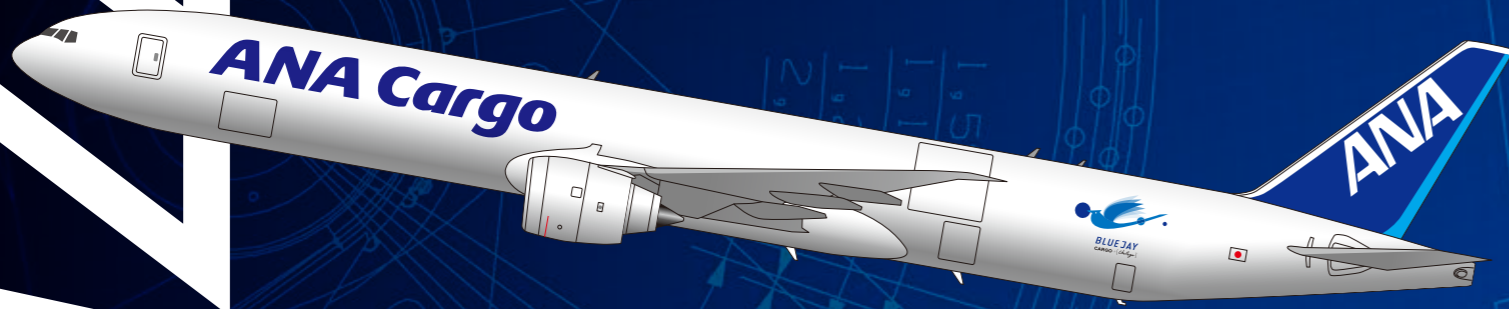

FREIGHTER



MAIN DECK

96 or 88 Pallet side by side version
27 Pallets (96 x 125-in or 88 x 125-in)

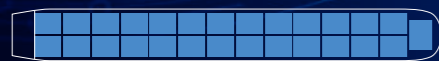

96 Pallet center load version

13 Pallets (96 x 125-in)
+ 1 Pallet (96 x 125-in or 88 x 125-in)

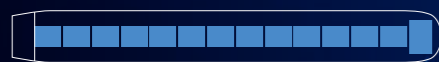

16 feet or 20 feet Pallet Center load version

9 Pallets (16-ft or 20-ft)
+ 3 Pallets (96 x 125-in or 88 x 125-in)

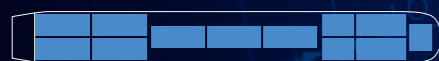

LOWER DECK

Pallet main version
10 Pallets(96 x 125-in or 88 x 125-in)+2 Containers(LD-3)



All container version

32 Containers (LD-3)



CROSS SECTION

96 or 88 Pallet Side by Side version

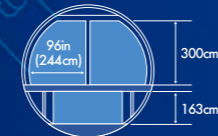

96 Pallet center load version

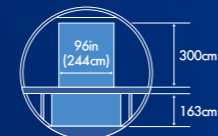

16 feet or 20 feet Pallet center load version

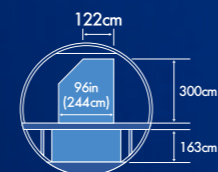

B767

B767 freighter

This freighter has a cruising range of 6,000 km and load capacity of approximately 50 tons. Efficiently transports cargo via intra-Asian network.

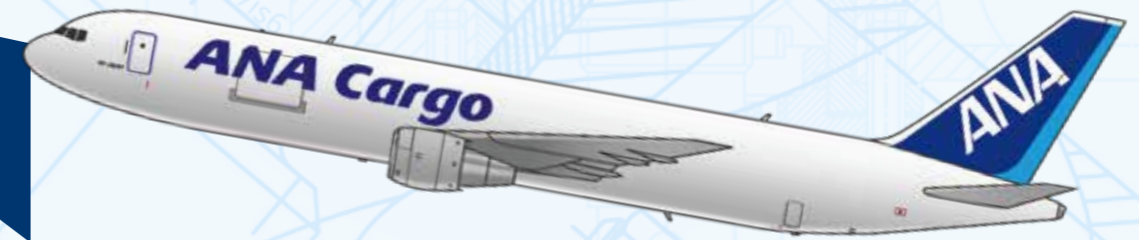

FREIGHTER

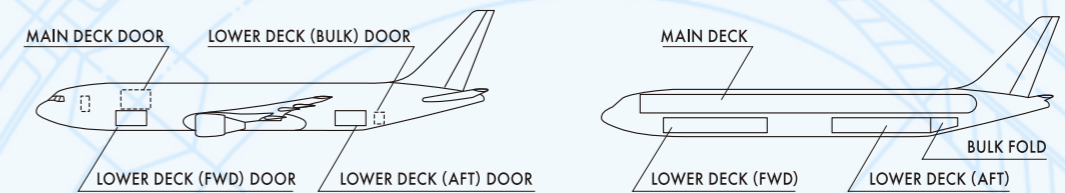

MAIN DECK

Side by side version
21 Pallets (88 x 125-in)+1 Pallet (96 x 125-in)

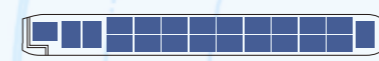

Transverse version

13 Pallets (96 x 125-in)
+3 Pallets (88 x 125-in or 88 x 125-in)



LOWER DECK

Pallet main version
7 Pallets(96 x 125-in or 88 x 125-in)+1 Containers(LD-8)

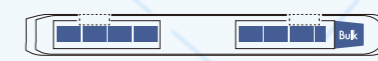

All Container version

15 Containers(LD-8)



CROSS SECTION

Side by side version

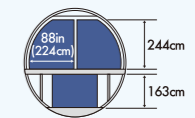

Transverse version

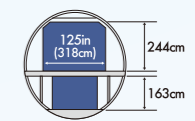

Utilizing passenger flight network, cargos are efficiently and speedily transported

ANA's passenger flight network extends to all over Japan, currently serving most destinations in the country.

Both our domestic and international routes boast an impressive scale.

By fully utilizing passenger aircrafts' cargo space, efficiency and speed of cargo transport is being enhanced.

Rich variety of air container types enables to accommodate wide range of cargos with diversifying characteristics

In light of diversifying cargo characteristics such as size, shape, and temperature control, various types of air containers with different sizes, materials, and functions are in possession. Every efforts are made to improve transport quality by utilizing these containers in accordance with the customers' needs.

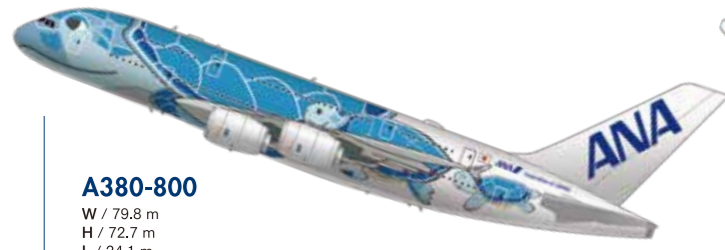

A380-800
W / 79.8 m
H / 72.7 m
L / 24.1 m
Cruising range / 13,330 km
Maximum weight on board / 43,236kg



B777-300
W / 60.9m (-300ER: 64.8m)
H / 73.9m
L / 18.5m
Cruising range / 3,800km (-300ER: 14,900km)
Maximum weight on board / 76,656kg



B787-10
W / 60.1 m
H / 68.3 m
L / 17.0 m
Cruising range / 11,600 km
Maximum weight on board / 70,319kg



B777-200
W / 60.9m
H / 63.7m
L / 18.5m
Cruising range / 3,800km
Maximum weight on board / 56,925kg



B787-9
W / 60.1m
H / 62.8m
L / 17.0m
Cruising range / 10,690km (INT: 14,960km)
Maximum weight on board / 60,395kg



B787-8
W / 60.1m
H / 56.7m
L / 16.9m
Cruising range / 4,890km (INT: 12,020km; 14,740km)
Maximum weight on board / 44,175kg



B767-300
W / 47.6m (-300ER with winglet: 50.9m)
H / 54.9m
L / 15.9m
Cruising range / 3,370km (-300ER: 10,030km; 10,820km)
Maximum weight on board / 28,824kg



AIRBUS A321
W / 35.8m
H / 44.5m
L / 11.8m
Cruising range / 2,720km
Maximum weight on board / 12,837kg



AIRBUS A320
W / 34.1m (INT: 35.8m)
H / 37.6m
L / 11.8m (INT: 12.1m)
Cruising range / 2,380km (INT: 5,790km)
Maximum weight on board / 9,435kg

Major examples of ULDs

containers



AAX
Internal capacity: m³(ft³) 13.7(484)
External dimensions / L x W x H: cm (inches) 318 x 224 x 243 (125 x 88 x 96)
Door size: cm (inches) 295 x 233 (116 x 92)
Loadable aircraft B767F/B777F



AKE (LD-3)
Internal capacity: m³(ft³) 4.4(156)
External dimensions / L x W x H: cm (inches) 156 x 153 x 163 (61.5 x 60.4 x 64)
Door size: cm (inches) 138 x 153 (54.3 x 60.4)
Loadable aircraft B777/B787/B767/A380



DQP (LD-4)
Internal capacity: m³(ft³) 5.5(194)
External dimensions / L x W x H: cm (inches) 244 x 153 x 163 (96 x 60.4 x 64)
Door size: cm (inches) 231 x 148 (91 x 58)
Loadable aircraft B777/B767/B787



AMA
Internal capacity: m³(ft³) 17.1(604)
External dimensions / L x W x H: cm (inches) 318 x 244 x 242 (125 x 96 x 95.3)
Door size: cm (inches) 293 x 228 (115 x 90)
Loadable aircraft B767F/B777F



DQF (LD-8)
Internal capacity: m³(ft³) 7.2(253)
External dimensions / L x W x H: cm (inches) 244 x 153 x 163 (96 x 60.4 x 64)
Door size: cm (inches) 225 x 154 (88 x 60)
Loadable aircraft B777-200-300/B787-8/B767

Chilled containers



RKN (LD-3F)
Internal capacity: m³(ft³) 3.5(123)
External dimensions / L x W x H: cm (inches) 156 x 153 x 163 (61.5 x 60.4 x 64)
Door size: cm (inches) 142 x 140 (56 x 55)
Loadable aircraft B777/B787/B767/A380
*Inside Temp -20~+20°C
*Coolant DRY-ICE
*FANTYPE



RKN-t2
Internal capacity: m³(ft³) 3.5(123)
External dimensions / L x W x H: cm (inches) 156 x 153 x 163 (61.5 x 60.4 x 64)
Door size: cm (inches) 142 x 140 (56 x 55)
Loadable aircraft B747/B777/B767/B787/A380
Photo: Envirotainer AB



RAP (LD-9)
Internal capacity: m³(ft³) 8.9(314)
External dimensions / L x W x H: cm (inches) 318 x 224 x 163 (125 x 88 x 64)
Door size: cm (inches) 278 x 145 (109 x 57)
Loadable aircraft B777/B787B/767ER/A380
*Inside Temp -20~+20°C
*Coolant DRY-ICE
*FANTYPE

Palette

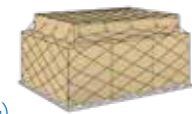

PAP,PAG (Pallet)
External dimensions / L x W x H: cm (inches) 318 x 224 x 163 (125 x 88 x 64)
Loadable aircraft B777/B787A380/B767ER/B767F/B777F



PMP,PMC (Pallet)
External dimensions / L x W x H: cm (inches) 318 x 244 x 163 (125 x 96 x 64)
Loadable aircraft B777/B787/B767ER/A380/B767F/B777F

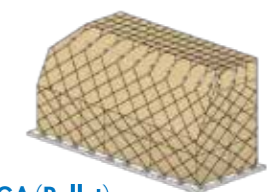

PGA (Pallet)
External dimensions / L x W x H: cm (inches) 606 x 244 x 299 (238 x 96 x 118)
Loadable aircraft B777F

Meeting diversifying needs: ANA Cargo's **PRIO** series

Our "PRIO" series meets the needs of a wide range of global businesses with a "guarantee priority." In order to deliver our precious cargo faster and more accurately to logistics bases around the world, we offer a wide variety of services.

For urgent cargo



Transport service you can rely on in emergencies

Reserve the service up to 120 minutes before departure, and we can accept the items up to 60 minutes before departure and hand them over within 90 minutes of arrival. Use this for urgent cargo transport.



For space guaranteed service



We promise to load it without fail on the flight you reserve

No matter the size, weight, or item, we offer a 100% guarantee that it will be loaded onto the reserved flight.



For specified temperature



We safely transport pharmaceutical products using dedicated equipment

We use all kinds of active and passive temperature-controlled containers. We protect the quality using dedicated handling procedures specialized for pharmaceutical products.



We offer thorough temperature control

This service is for cargo requiring temperature control, such as perishables, frozen foods, and chemical products. We accommodate a wide range of temperature control methods, such as dry ice, rechargeable compressors, and special cooling materials, that can be selected according to your needs.



ANA obtained IATA CEIV Pharma Certification. (For details, see P.18)

For special cargo



We make thorough preparations for impact risk We can safely transport precision instruments

We handle them in a way that accounts for the impact risk. This is a reliable service for transporting things like shock watch and tilt watch-fitted semiconductor manufacturing equipment and medical equipment.



Reliable automobile transport covering a variety of vehicle types

Utilizing our skilled staff and our freighter network, we handle autos ranging from compact cars to SUVs. We'll deliver them to all kinds of situations, such as motor shows and tests.



We have a thoroughgoing system for delivering things like artwork and instruments

For delicate cargo requiring special care. You can trust us to transport artwork received from overseas or instruments for a concert, for example.



Customs clearance services ※This service is applicable ONLY from Japan



We handle warehouse services and export/import customs clearance on your behalf

"PRIO EXPRESS," "PRIO FREIGHT," and "PRIO COOL" with the addition of warehouse services and export customs clearance agency services. It's convenient to use.



Connect from the nearest airport to overseas

"PRIO EXPRESS" and "PRIO FREIGHT" with the addition of warehouse services and export customs clearance agency services as well as connection to and from domestic and international routes at Haneda.



Pharmaceutical product transport based on global quality standards

ANA was the first Japanese airline to obtain IATA CEIV Pharma Certification at Narita International Airport.



What is IATA CEIV Pharma certification?

The letters stand for "The Center of Excellence for Independent Validation in Pharmaceutical Logistics." It's a quality certification program for the air transport of pharmaceutical products, formulated by the IATA.

This assures safety, security, compliance, and efficiency based on uniform international standards in accordance with Good Distribution Practices (GDP).

Scope of the certification scheme

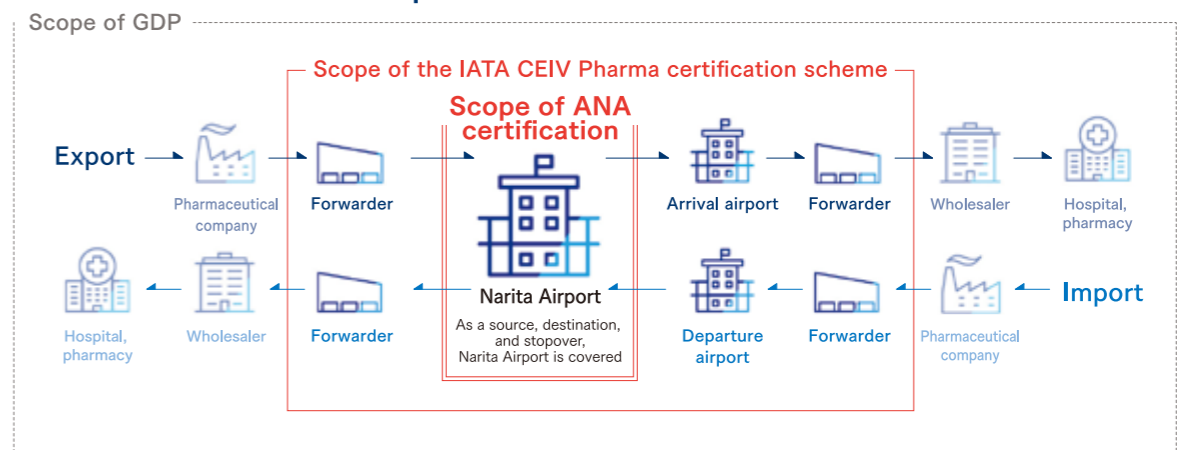

Reliable pharmaceutical product transport backed by certification

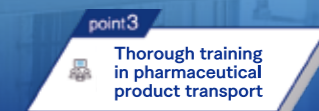
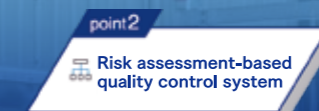
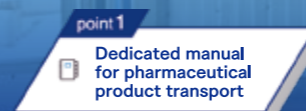

ANA Cargo offers GDP-compliant, highly transparent handling, enabling high-quality transport of pharmaceutical products.

